

Description

CM3400A is the N-Channel enhancement mode power field effect transistors with high cell density, trench technology. This high density process and design have been optimized switching performance and especially tailored to minimize on-state resistance.

Features

- V_{DS} : 30V
- I_D : 5.8A
- $R_{DS(on)}$ (@ $V_{GS}=10V$): < 29m Ω
- $R_{DS(on)}$ (@ $V_{GS}=4.5V$): < 35m Ω
- $R_{DS(on)}$ (@ $V_{GS}=2.5V$): < 51m Ω
- High density cell design for extremely low $R_{DS(on)}$
- Excellent on-resistance and DC current capability

Equivalent Circuit and Pin Configuration

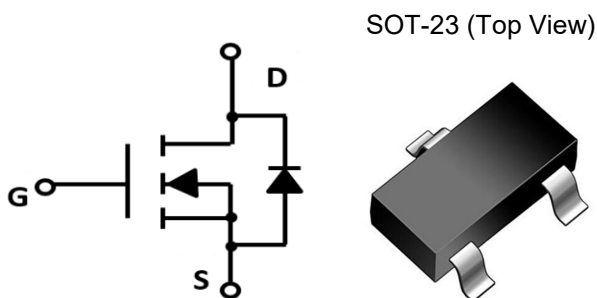

Applications

- Cellular Handsets and Accessories
- Personal Digital Assistants
- Portable Instrumentation
- Load switch

Marking Information

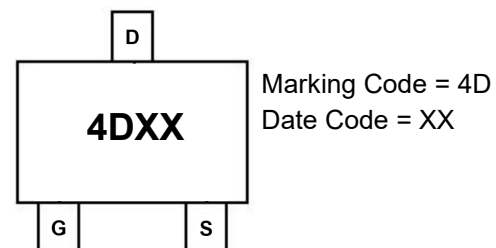

Ordering Information

Part Number	Packaging	Reel Size
CM3400A	3000/Tape & Reel	7 inch

Absolute Maximum Ratings (TA=25 °C unless otherwise noted)

Parameter	Symbol	Maximum	Unit	
Drain-source Voltage	V_{DS}	30	V	
Gate-source Voltage	V_{GS}	± 10	V	
Continuous Drain Current	I_D	$T_A=25^\circ C$	5.8	A
		$T_A=70^\circ C$	4.1	A
Pulsed Drain Current ⁽¹⁾	I_{DM}	23	A	
Total Power Dissipation @ $T_A=25^\circ C$ ⁽²⁾	P_D	1.4	W	
Thermal Resistance Junction-to-Ambient ⁽²⁾	$R_{\theta JA}$	90	$^\circ C/W$	
Junction and Storage Temperature Range	T_J, T_{STG}	-55 to +150	$^\circ C$	

Electrical Characteristics (T_J=25 °C unless otherwise noted)

Parameter	Symbol	Conditions	Min	Typ	Max	Units
Static Parameter						
Drain-Source Breakdown Voltage	BV _{DSS}	V _{GS} =0V, I _D =250μA	30			V
Zero Gate Voltage Drain Current	I _{DSS}	V _{DS} =30V, V _{GS} =0V, T _C =25°C			1	μA
Gate-Body Leakage Current	I _{GSS}	V _{GS} =±10V, V _{DS} =0V			±100	nA
Gate Threshold Voltage	V _{GS(th)}	V _{DS} =V _{GS} , I _D =250μA	0.65		1.5	V
Static Drain-Source on-Resistance	R _{DSON}	V _{GS} =10V, I _D =5.8A		24	29	mΩ
		V _{GS} =4.5V, I _D =5.0A		28	35	
		V _{GS} =2.5V, I _D =3.0A		39	51	
Diode Forward Voltage	V _{SD}	I _S =5.8A, V _{GS} =0V		0.8	1.2	V
Maximum Body-Diode Continuous Current	I _S				5.8	A
Dynamic Parameters						
Input Capacitance	C _{iss}	V _{DS} =15V, V _{GS} =0V, f=1MHz		460		pF
Output Capacitance	C _{oss}			55		
Reverse Transfer Capacitance	C _{rss}			42		
Switching Parameters						
Total Gate Charge	Q _g	V _{GS} =4.6V, V _{DS} =15V, I _D =5.8A		4.8		nC
Gate Source Charge	Q _{gs}			1.1		
Gate Drain Charge	Q _{gd}			1.4		
Turn-on Delay Time	t _{D(on)}	V _{GS} =4.5V, V _{DD} =15V, I _D =1A, R _{GEN} =2.8Ω		8.3		ns
Turn-on Rise Time	t _r			6.2		
Turn-off Delay Time	t _{D(off)}			28		
Turn-off Fall Time	t _f			11		

Noted: (1) Pulse Test: Pulse Width ≤ 300μs, Duty cycle ≤ 2%.

(2) Device mounted on FR-4 PCB, 1 inch x 0.85 inch x 0.062 inch. With 2oz Copper, t ≤ 10s

Typical Performance Characteristics

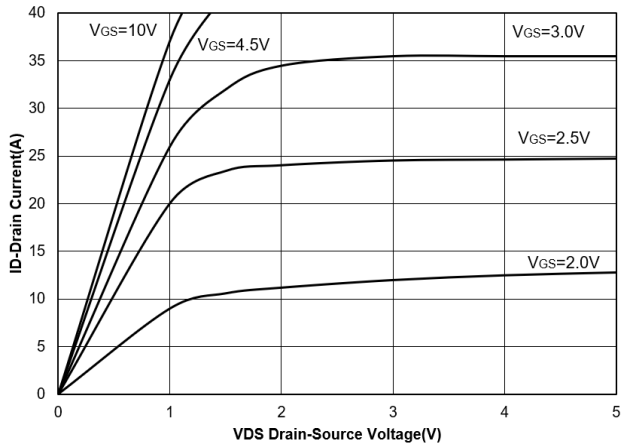

Figure 1. Output Characteristics

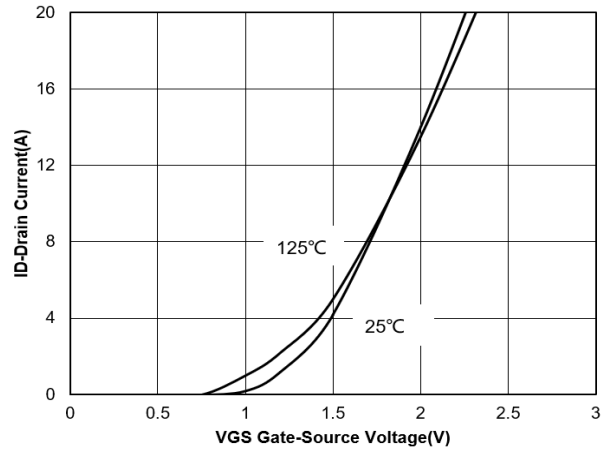

Figure 2. Transfer Characteristics

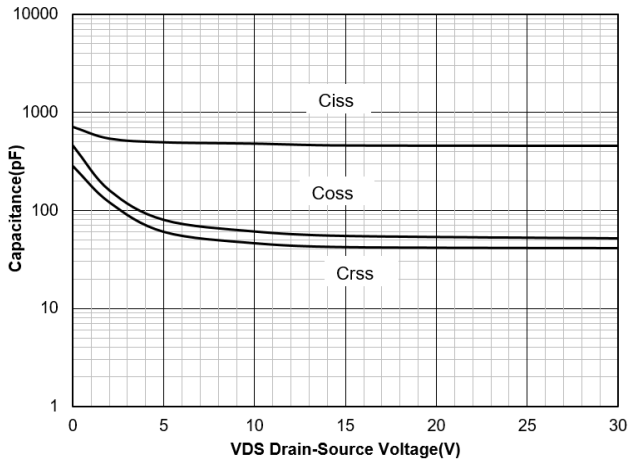

Figure 3. Capacitance Characteristics

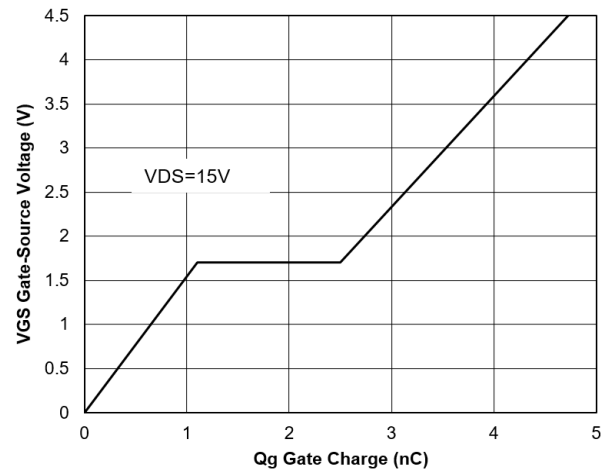

Figure 4. Gate Charge

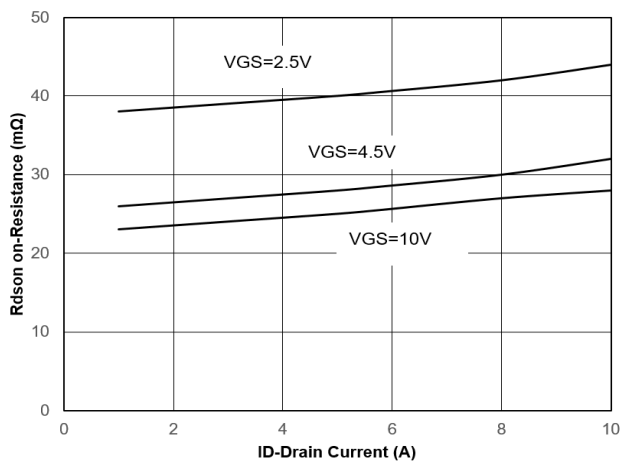

Figure 5. Drain-Source on Resistance

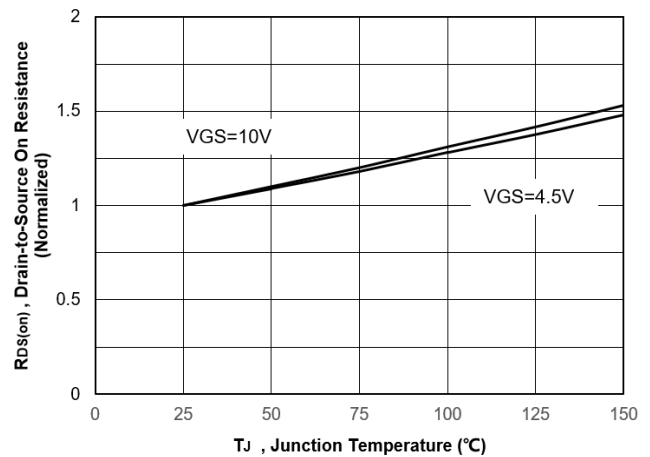

Figure 6. Normalized On-Resistance Vs. Temperature

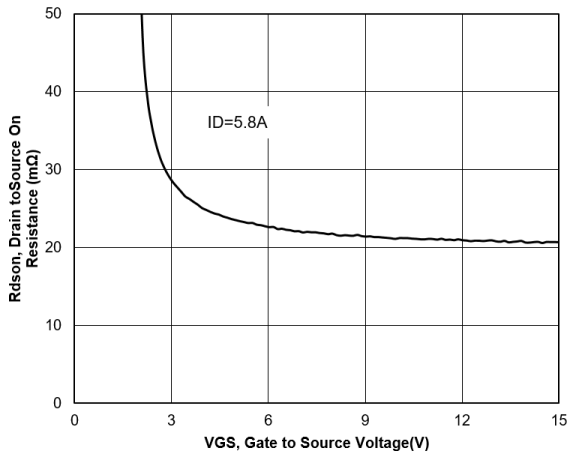

Figure 7. Typical Drain to Source ON Resistance

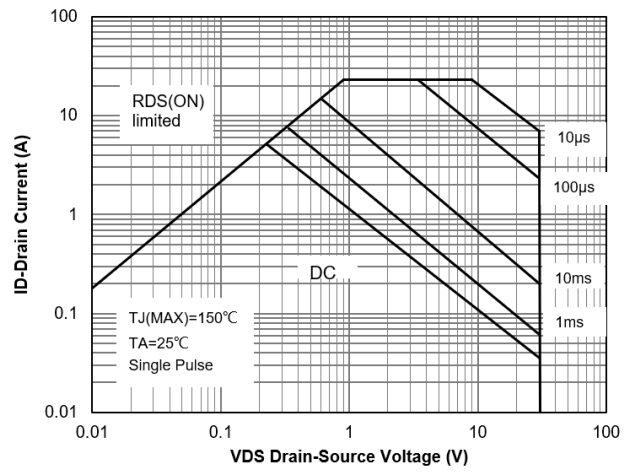

Figure 8. Safe Operation Area

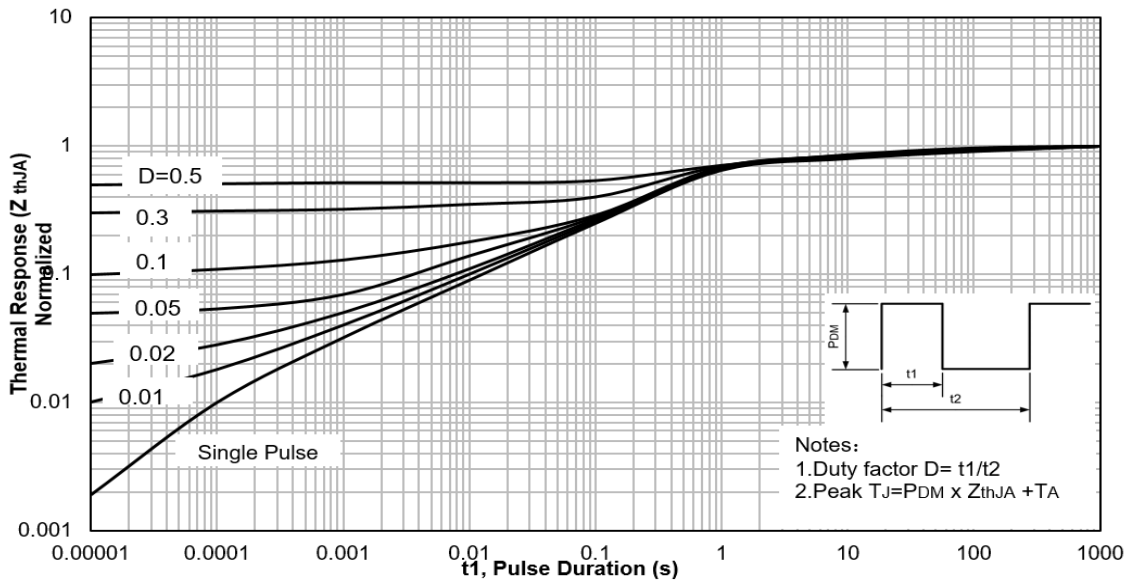

Figure 9. Maximum Effective Transient Thermal Impedance ,Junction-to-Ambient

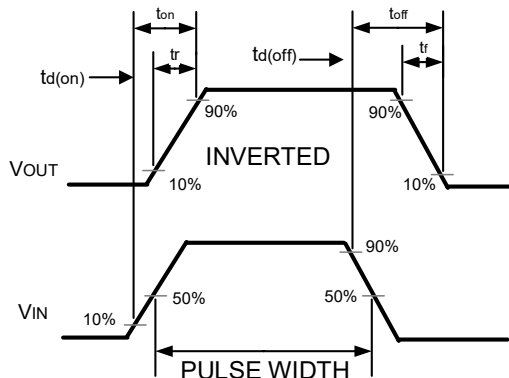
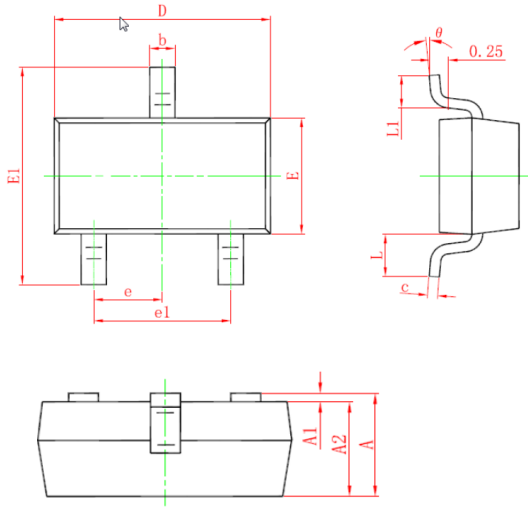

Figure 10. Switching wave

SOT-23 Package Outline Drawing



SYM	DIMENSIONS					
	MILLIMETERS			INCHES		
	MIN	NOM	MAX	MIN	NOM	MAX
A	0.90	--	1.15	0.035	--	0.045
A1	0.00	--	0.10	0.000	--	0.004
A2	0.90	--	1.05	0.035	--	0.041
b	0.30	--	0.50	0.012	--	0.020
c	0.08	--	0.15	0.003	--	0.006
D	2.80	--	3.00	0.110	--	0.118
E	1.20	--	1.40	0.047	--	0.055
E1	2.25	--	2.55	0.089		0.100
e	0.95TYP			0.037TYP		
e1	1.80	--	2.00	0.071	--	0.079
L	0.55REF			0.022REF		
L1	0.30	--	0.50	0.012	--	0.020
Θ	0°	--	8°	0°	--	8°

Suggested Land Pattern

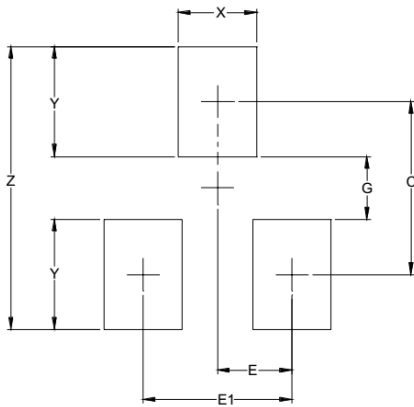

SYM	DIMENSIONS	
	INCHES	MILLIMETERS
C	0.087	2.20
E	0.037	0.95
E1	0.075	1.90
G	0.031	0.80
X	0.039	1.00
Y	0.055	1.40
Z	0.141	3.60

Contact Information

Applied Power Microelectronics Inc.

Website: <http://www.appliedpowermicro.com>

Email: sales@appliedpowermicro.com

Phone: +86 (0519) 8399 3606